

AquaSHIELD®

PROTECTIVE ENCLOSURES

1805 WEST 37TH PLACE
 NO. LITTLE ROCK, AR 72118
 501-791-1800 501-791-1801 FAX
 www.aquashieldenclosures.com

Enclosure Model # BFP8-O

Inside Dimensions: 120 "L x 38 "W x 78 "H

Outside Dimensions: 123 "L x 41 "W x 80 "H

Recommended Pad Size: 135 "L x 53 "W x 6 "H

Wall Thickness: 1.5"

Roof Thickness: 3"

Heat if Required: (2) 1500W/120V/1PH Heater

AquaSHIELD suggests power source for heat be
 a designated circuit with GFI Receptacle

ELEVATION VIEW

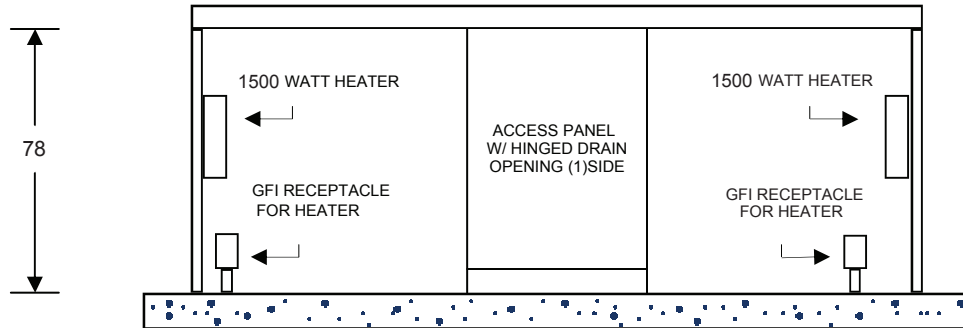

PLANVIEW

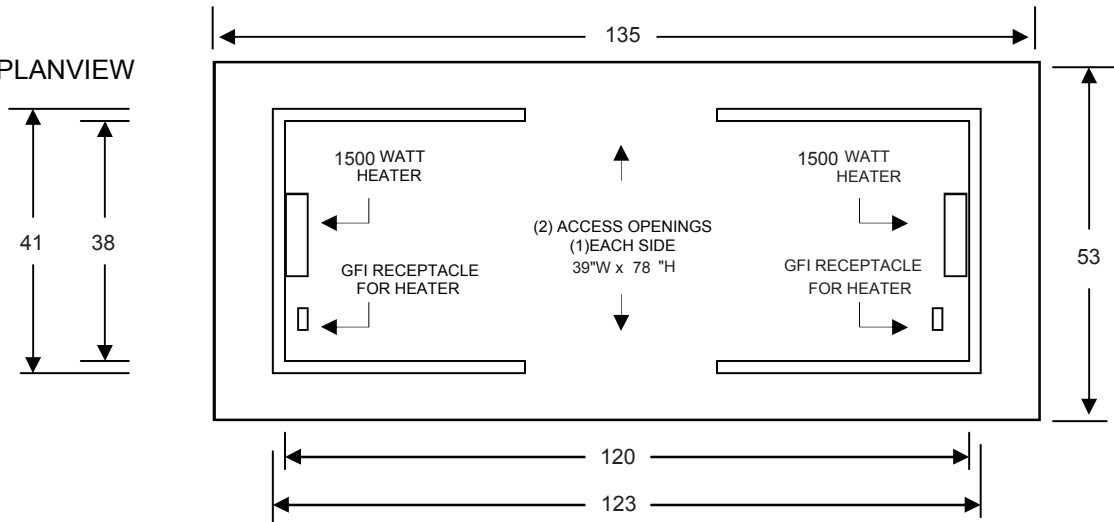

JOB:

DRAWN BY: WH
 SCALE: NONE
 DATE: 12/10/18

Drawing: NOT TO SCALE
 CONFIDENTIAL: This drawing is intended for use only
 by those authorized to receive it.
 Dissemination, distribution, or copy of the information is
 strictly prohibited